

Article number: 20804016

Description: E+G Thrust pad  
DIN 6311-16-S

## Measures

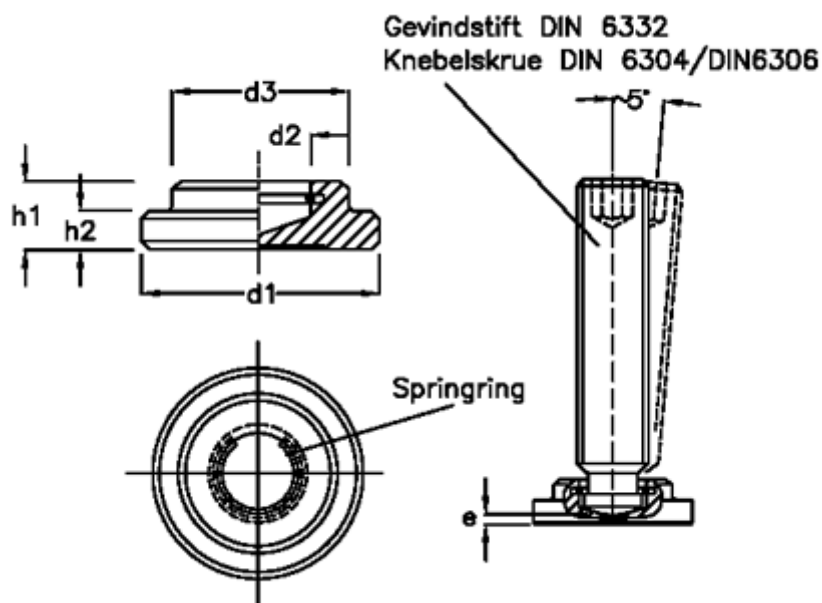

d1 = 16  
d2 = 6.1  
d3 = 12  
e = 3.0  
h1 = 9  
h2 = 4.0  
T = M8